

ESPECIFICACIONES

STAGE V



Este implemento está aprobado, pero no suministrado, por JCB.

EXCAVADORA DE RUEDAS | JS175W

Potencia del motor: 129 kW (173 hp) Capacidad del cazo: 0,25 – 0,87 m³ Peso operativo: 16.256 – 18.982 kg

JCB

RESISTENCIA Y DURABILIDAD.

En las excavadoras JCB, la resistencia y la durabilidad vienen de serie. Un diseño, una fabricación y un montaje avanzados dan lugar a unos componentes de calidad hechos para durar.



TIEMPO DE INACTIVIDAD MÍNIMO.

La regeneración automática minimiza los tiempos de inactividad, mientras que funciones como la parada automática y el ralentí automático reducen el tiempo que el motor pasa en ralentí.

PRODUCTIVIDAD Y RENDIMIENTO.

Nuestra gama de excavadora de ruedas está diseñada para aprovechar su tiempo y su dinero de la manera más eficiente gracias al uso de innovadoras funciones de Etapa V.

UNA OFICINA MUY CÓMODA.

Nuestra cabina alberga toda una serie de avanzadas funciones tecnológicas, además de contar con un diseño ergonómico, para crear un entorno de trabajo confortable para los operadores.



MAYOR FACILIDAD DE MANTENIMIENTO.

Nuestra gama de excavadoras está diseñada para requerir un bajo nivel de mantenimiento y poder llevar a cabo las labores de servicio con facilidad. Cuando hay que hacer el mantenimiento, es rápido y sencillo.

LA ELECCIÓN SEGURA.

La seguridad del operador y de todas las personas de la obra es lo más importante. Por eso, nuestras máquinas incorporan muchas características que minimizan los riesgos y crean un entorno más seguro.

DIMENSIONES ESTÁTICAS

PESO OPERATIVO MÁX.: 18.982 kg POTENCIA DEL MOTOR: 129 kW (173 hp)

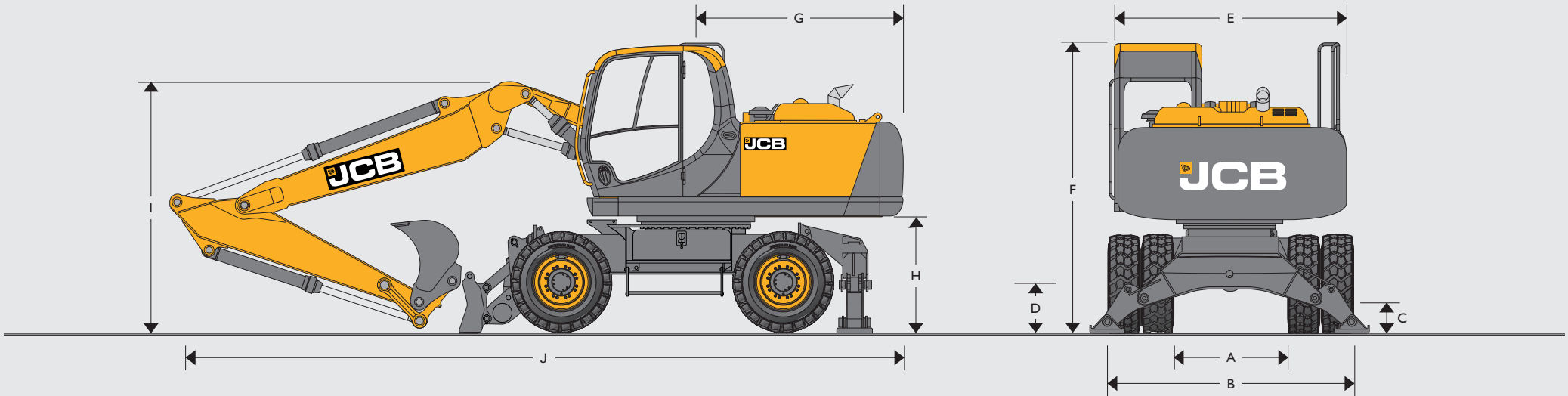

DIMENSIONES ESTÁTICAS

A	Anchura interna entre ruedas dobles	mm	1330
B	Anchura externa sobre ruedas dobles	mm	2498 (JCB), 2528 (ZF)
C	Altura libre	mm	350
D	Altura a la línea central del eje de las ruedas dobles	mm	498
	Altura a la línea central del eje de las ruedas simples	mm	519
E	Anchura total (sin pasamanos)	mm	2480
F	Altura sobre la cabina	mm	3195
G	Longitud trasera	mm	2330
H	Altura libre bajo el contrapeso	mm	1270

Monoboomb 5,15 m

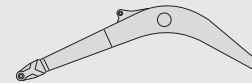

Longitud del balancín		2,25 m	2,70 m	3,05 m
I	Altura de transporte de la pluma	mm	2765	3240
J	Longitud de transporte:	mm	8285	8446

Pluma articulada triple 4,97 m

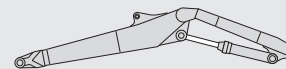

Longitud del balancín		2,25 m	2,70 m	3,05 m
I	Altura de transporte de la pluma	mm	2806	3136
J	Longitud de transporte:	mm	8263	8223

OPCIONES DEL CHASIS

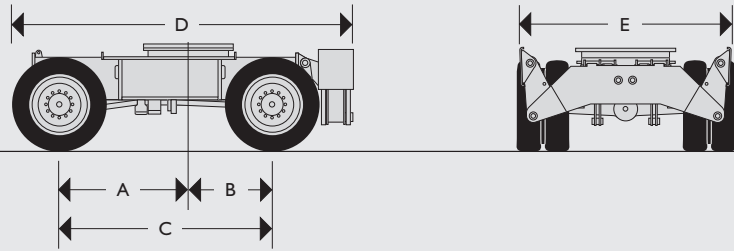

ESTABILIZADORES DETRÁS

A	Del centro del aro de giro al eje delantero	mm	1500
B	Del centro del aro de giro al eje trasero	mm	1000
C	Distancia entre ejes	mm	2500
D	Longitud incluyendo los estabilizadores traseros	mm	3950
E	Anchura sobre los estabilizadores (levantados)	mm	2480

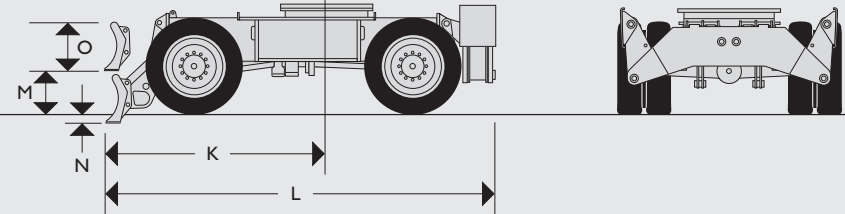

ESTABILIZADOR DELANTERO DÓZER

K	Del centro del aro de giro a la hoja dózer delantera (bajada)	mm	2530
L	Longitud incluyendo estabilizadores y hoja dózer (levantada)	mm	4460
M	Del nivel del suelo a la parte inferior de la hoja dózer delantera (levantada)	mm	450
N	Profundidad de excavación de la hoja dózer	mm	130
O	Altura de la hoja dózer	mm	500

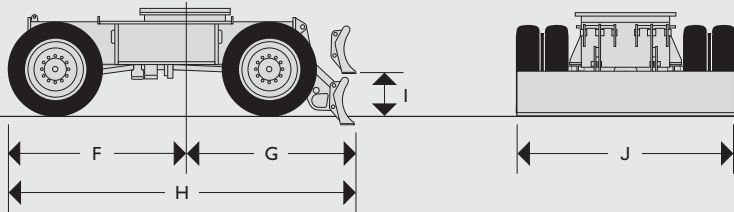

DÓZER DETRÁS

F	Del centro del aro de giro a la cara del neumático delantero	mm	1990
G	Del centro del aro de giro a la hoja dózer trasera (bajada)	mm	2090
H	Longitud incluyendo hoja dózer trasera (levantada)	mm	4050
I	Del nivel del suelo a la parte inferior de la hoja dózer trasera (levantada)	mm	450
J	Ancho de la hoja dózer	mm	2480

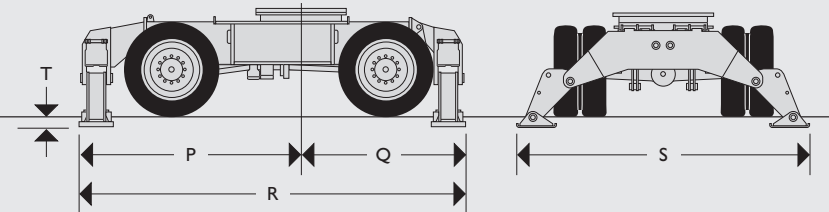

ESTABILIZADORES DELANTE Y DETRÁS

P	Del centro del aro de giro a los estabilizadores delanteros	mm	2520
Q	Del centro del aro de giro a los estabilizadores traseros	mm	1960
R	Longitud incluyendo los estabilizadores delanteros y traseros	mm	4480
S	Anchura sobre los estabilizadores (bajados)	mm	3550
T	Altura de elevación de los estabilizadores	mm	130





MOTOR	
Modelo	JCB Dieselmex 448 TCA Etapa V de la UE
Tipo:	4 tiempos, 4 cilindros en línea, common rail, inyección directa, diésel con turbocompresor e intercooler
Potencia nominal (ISO 14396)	129 kW (173 hp) a 2050 rpm.
Desplazamiento del pistón	4,8 litros.
Inyección	Inyección electrónica
Filtración del aire	Elemento seco con elemento de seguridad secundario e indicador de advertencia en la cabina
Refrigeración	Radiador de gran capacidad.
Sistema de arranque	24 voltios – 4 kW.
Baterías	2 x 12 voltios.
Alternador	24 voltios – 100 amperios
Bomba de repostaje	Tipo eléctrico (opcional)

SISTEMA DE ROTACIÓN	
Grupo de engranajes conductores	Transmisión final de motor de pistón axial y reducción planetaria.
Freno de rotación	Frenado hidráulico más freno de estacionamiento automático tipo disco aplicado por resorte.
Velocidad de rotación	11,3 rpm
Engranaje de rotación	De gran diámetro, con dentado interno, totalmente sellado y lubricado en baño de grasa.
Bloqueo de giro	Freno conmutable multiposición y bloqueo mecánico.

CHASIS			
Opciones del chasis	Ejes de freno de cubo ZF de 2,5 m / eje de freno de disco JCB de 2,5 m.		
Hoja dózer	Montaje de pasador delantero o trasero.		
Estabilizadores	Montaje de pasador delantero o trasero, operables de manera independiente (más combinaciones).		
Agarre de estiba	Barra de estiba para trabajos pesados con montaje de pasador.		
Ejes:	Tracción a las cuatro ruedas.		
Capacidad de carga de los ejes	25 toneladas (JCB), 32 toneladas (ZF)		
Oscilación de los ejes	+/-8,5 grados.		
Altura libre	350 mm		
Transmisión	Accionamiento hidrostático mediante motor de pistones y transmisión powershift		
Velocidad de desplazamiento	Velocidad de marcha lenta	3,8 km/h (JCB)	3,8 km/h (ZF)
	Baja relación	14 km/h (JCB)	14 km/h (ZF)
	Alta relación	30 km/h (JCB)	30 km/h (ZF)
Esfuerzo sobre el gancho de tracción	99,7 kN (eje JCB), 102,5 kN (eje ZF)		
Dirección	Sistema completamente hidráulico.		
Radio de giro			
Al exterior de los neumáticos	6,66 m (JCB), 6,22 (ZF)		
Al exterior de la hoja dózer montada en la parte delantera	7,09 m (JCB), 6,67 (ZF)		
Frenos	Sistema de frenado de circuito doble totalmente hidráulico.		
Freno de estacionamiento	Integrado en la transmisión.		
Pendiente admisible	Máx. 35° 70 % continua.		

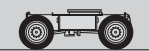
NEUMÁTICOS			
	Dobles	Sencillos	Flotación
Neumáticos 10,00 x 20 (16PR) con aro separador		Neumáticos 18R x 19,5 (Radiales)	600/40 x 22,5

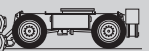
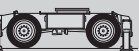
PESOS OPERATIVOS

Chasis					
	16.256 kg	17.126 kg	17.241 kg	18.111 kg	18.226 kg
	17.012 kg	17.883 kg	17.997 kg	18.868 kg	18.982 kg

Máquina equipada con balancín de 3,05 m, cazo excavador y ruedas dobles. Para una máquina con ruedas simples, sustraer 400 kg.

COMBINACIÓN DE CUCHARA Y BRAZO

Longitud del brazo	Sin conector rápido			Con conector rápido*			Peso de la cuchara
	2,25 m	2,7 m	3,05 m	2,25 m	2,7 m	3,05 m	
JS175W Mono							
Cazo GP 457 mm 0,25 m ³	□	□	□	□	□	□	348 kg
Cazo GP 610 mm 0,33 m ³	□	□	□	□	□	□	381 kg
Cazo GP 762 mm 0,46 m ³	□	□	□	□	□	■	428 kg
Cazo GP 1067 mm 0,73 m ³	■	■	●	●	●	×	526 kg
Cazo GP 1219 mm 0,87 m ³	●	●	×	×	×	×	580 kg
JS175W Tab							
Cazo GP 457 mm 0,25 m ³	□	□	□	□	□	□	348 kg
Cazo GP 610 mm 0,33 m ³	□	□	□	□	□	□	381 kg
Cazo GP 762 mm 0,46 m ³	□	□	□	□	□	■	428 kg
Cazo GP 1067 mm 0,73 m ³	■	■	●	●	●	×	526 kg
Cazo GP 1219 mm 0,87 m ³	●	●	×	×	×	×	580 kg

Notas: Compatibilidad del cazo basada en los valores de elevación (ISO 10567) para una máquina con dózer trasero; la compatibilidad varía en función de las opciones del chasis

□ = Adecuado para excavación general (materiales de hasta 2000 kg/m³).

■ = Adecuado para excavación ligera (materiales de hasta 1600 kg/m³).

● = Adecuado para nivelación y carga (materiales de hasta 1200 kg/m³).

× = No recomendado

* Capacidad del cazo utilizando solo el enganche rápido de JCB (enganche rápido = 288 kg).

CAPACIDADES DE SERVICIO

Depósito de combustible	Litros	310
Refrigerante del motor	Litros	26
Aceite del motor	Litros	20,4
Engranaje reductor de la rotación	Litros	6
Sistema hidráulico	Litros	124
Depósito hidráulico	Litros	73
Transmisión	Litros	2,5
Diferenciales de los ejes (cada uno)	Litros	Traseros 12, delanteros 14
Cubos de los ejes	Litros	2,0
Capacidad del fluido DEF	Litros	31,4

SISTEMA HIDRÁULICO PRINCIPAL

Sistema	Sistema hidráulico de control negativo y centro abierto con bombas de pistón dobles de flujo variable que proporcionan caudal según demanda para una máxima eficiencia.
Bombas principales	2 tipo pistón axial de desplazamiento variable.
Caudal máximo	2 x 156 l/min.
Presión del circuito principal	314 bar.
Con aumento de potencia	343 bar.
Bombas servo	Tipo de engranaje.
Caudal máximo	27 l/min.
Presión servo	40 bar.
Circuitos opcionales	
Martillo	Incluye ajuste automático de la velocidad del motor y filtro de retorno.
Caudal máximo	138 l/min.
Presión máxima	314 bar (ajustada a 180 bar).
Auxiliar de doble efecto	
Caudal máximo	130 l/min.
Presión máxima para la operación de agarre del pistón	314 (343) bar.
Tuberías de bajo caudal	Caudal máx. de la bomba de engranaje 36 l/min.
Cilindros hidráulicos	Vástagos de pistón y amortiguación de los extremos endurecidos y cromados en la pluma, el balancín y el cilindro de empuje del cucharón.
Filtrado	
En el depósito	150 micras, filtro de succión.
Tubería de retorno principal	10 micras, elemento de fibreform.
Tubería del piloto	10 micras, elemento de papel.
Retorno del martillo hidráulico	10 micras, elemento de microforma reforzada.
Refrigeración	Se proporciona refrigeración en cualquier lugar del mundo mediante un intercooler de agua y aceite hidráulico de una sola cara del motor con condensador del aire acondicionado desplazable hacia adelante para facilitar la limpieza.

RANGOS DE TRABAJO

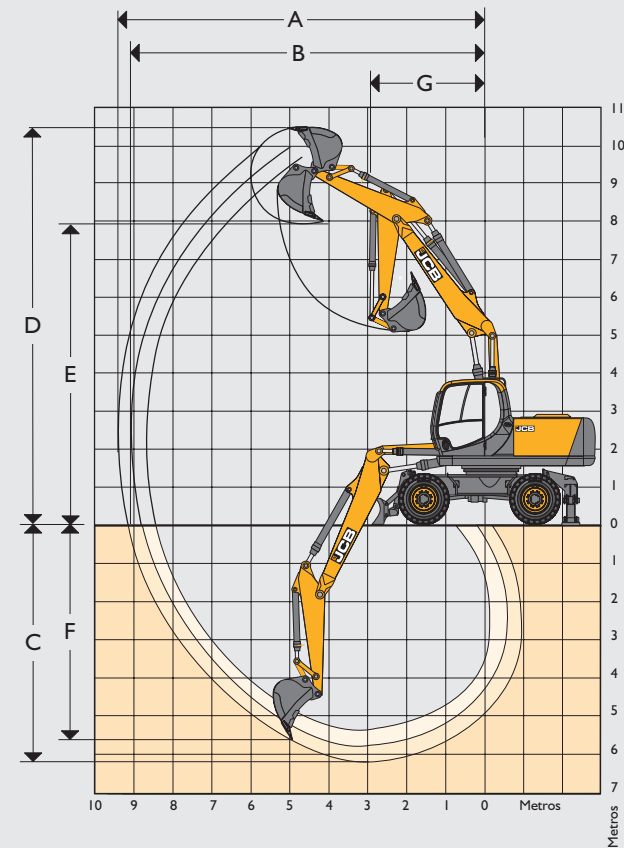
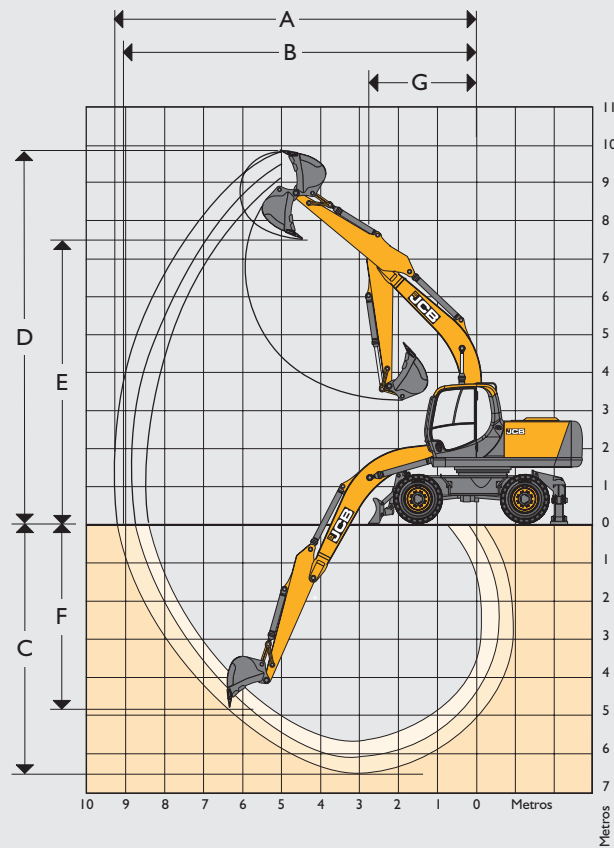

Monoboom 5,15 m:









Longitud del balancín	2,25 m	2,70 m	3,05 m
A Alcance máx. de excavación	mm 8592	8974	9483
B Alcance máx. de excavación (sobre el terreno)	mm 8386	8776	9234
C Profundidad de excavación máx.	mm 5682	6120	6256
D Altura máx. de excavación	mm 9102	9237	9688
E Altura máx. de carga elevada	mm 6636	6805	7174
F Profundidad máx. de corte de pared vertical	mm 3826	4178	4839
G Radio de rotación mín.	mm 3019	2961	2971
Rotación del cazo	183°	183°	183°
Fuerza de arranque del balancín	kgf 10.128	8440	7470
Fuerza de arranque del balancín con aumento de la potencia	kgf 10.990	9160	8100
Fuerza de arranque de la cuchara	kgf 10.400	10.400	10.400
Fuerza de arranque del cazo con aumento de la potencia	kgf 10.740	10.740	10.740

T.A.B. 4,97 m

Longitud del balancín	2,25 m	2,70 m	3,05 m
A Alcance máx. de excavación	mm 8600	9025	9350
B Alcance máx. de excavación (sobre el terreno)	mm 8400	8850	9195
C Profundidad de excavación máx.	mm 5300	5750	6100
D Altura máx. de excavación	mm 9700	10.000	10.235
E Altura máx. de carga elevada	mm 7000	7325	7575
F Profundidad máx. de corte de pared vertical	mm 4450	4900	5250
G Radio de rotación mín.	mm 2725	2675	2635
Rotación del cazo	183°	183°	183°
Fuerza de arranque del balancín	kgf 9035	7530	6665
Fuerza de arranque del balancín con aumento de la potencia	kgf 9600	8100	7235
Fuerza de arranque de la cuchara	kgf 10.400	10.400	10.400
Fuerza de arranque del cazo con aumento de la potencia	kgf 10.740	10.740	10.740





CAPACIDADES DE ELEVACIÓN – LONGITUD DEL BALANCÍN: 2,25 M, MONOBOOM 5,15 M, DÓZER TRASERO, SIN CAZO.

JSI75W MONO

Alcance	1,5 m		3 m		4,5 m		6 m		7,5 m		Capacidad a alcance máx.		
													mm
Altura del punto de carga	kg	kg	kg	kg	kg	kg	kg	kg	kg	kg	kg	kg	mm
7,5 m					4360*	4360*					3830*	3830*	4620
6,0 m					5080*	4470	3530*	2760			3330*	2740	6031
4,5 m					5710*	4260	4890*	2730			3190*	2190	6838
3,0 m					6740*	3940	5250*	2600			3230*	1940	7248
1,5 m					7530*	3650	5580*	2470			3440*	1850	7330
0 m			5580*	5580*	7600*	3510	5600*	2380			3880*	1910	7094
- 1,5 m	6310*	6310*	9440*	6460	6950*	3490	5060*	2370			4400*	2150	6508
- 3,0 m	8760*	8760*	7190*	6620	5360*	3580					4000*	2790	5454
- 4,5 m			2810*	2810*							2280*	2280*	3524

CAPACIDADES DE ELEVACIÓN – LONGITUD DEL BALANCÍN: 2,70 M, MONOBOOM 5,15 M, DÓZER TRASERO, SIN CAZO.

JSI75W MONO

Alcance	1,5 m		3 m		4,5 m		6 m		7,5 m		Capacidad a alcance máx.		
													mm
Altura del punto de carga	kg	kg	kg	kg	kg	kg	kg	kg	kg	kg	kg	kg	mm
7,5 m											2880*	2880*	5238
6,0 m							4040*	2860			2580*	2460	6514
4,5 m					5290*	4370	4610*	2780			2500*	2010	7266
3,0 m			9710*	7300	6360*	4010	5040*	2630	3370*	1860	2540*	1800	7653
1,5 m			5120*	5120*	7290*	3680	5450*	2480	4100*	1800	2690*	1710	7731
0 m			6660*	6250	7590*	3480	5600*	2360	3080*	1750	3020*	1750	7508
- 1,5 m	6070*	6070*	10.140*	6280	7170*	3420	5280*	2320			3630*	1930	6957
- 3,0 m	10.160*	10.160*	8130*	6430	5930*	3480					4020*	2400	5985
- 4,5 m			4570*	4570*							3120*	3120*	4307

CAPACIDADES DE ELEVACIÓN – LONGITUD DEL BALANCÍN: 3,05 M, MONOBOOM 5,15 M, DÓZER TRASERO, SIN CAZO.

JSI75W MONO



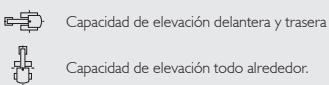







Alcance	1,5 m		3 m		4,5 m		6 m		7,5 m		Capacidad a alcance máx.		
													mm
Altura del punto de carga	kg	kg	kg	kg	kg	kg	kg	kg	kg	kg	kg	kg	mm
7,5 m											2400*	2400*	5690
6,0 m							3840*	2860			2170*	2170	6881
4,5 m							4350*	2780	2500*	1890	2110*	1840	7596
3,0 m			8930*	7540	6020*	4060	4830*	2630	3790*	1840	2150*	1650	7967
1,5 m			6790*	6590	7070*	3700	5300*	2460	4270	1760	2280*	1580	8041
0 m			6950*	6270	7540*	3470	5540*	2340	4200	1710	2540*	1600	7828
- 1,5 m	5610*	5610*	9860*	6240	7290*	3390	5350*	2280			3040*	1760	7301
- 3,0 m	9050*	9050*	8780*	6350	6260*	3420	4430*	2310			3920*	2140	6383
- 4,5 m	7560*	7560*	5630*	5630*	3860*	3600					3340*	3260	4849



- Notas:
1. Para obtener la capacidad de elevación incluyendo el cazo, sustraiga el peso total del cazo o el cazo y el enganche rápido de los valores anteriores.
 2. Las capacidades de elevación están basadas en ISO 10567, es decir: 75 % de la carga basculante mínima u 87 % de la capacidad de elevación del sistema hidráulico, la que sea menor. Las capacidades de elevación marcadas con un asterisco (*) se basan en la capacidad del sistema hidráulico.
 3. Para las capacidades de elevación se presupone que la máquina está en un terreno firme y nivelado.
 4. Las capacidades de elevación pueden estar limitadas por las normas locales. Póngase en contacto con su distribuidor.

CAPACIDADES DE ELEVACIÓN – LONGITUD DEL BALANCÍN: 2,25 M, MONOBOOM 5,15 M, ESTABILIZADORES TRASEROS, SIN CAZO.

JSI75W MONO

Alcance	1,5 m		3 m		4,5 m		6 m		7,5 m		Capacidad a alcance máx.		mm
													
Altura del punto de carga	kg	kg	kg	kg	kg	kg	kg	kg	kg	kg	kg	kg	
7,5 m					4360*	4360*					3830*	3830*	4620
6,0 m					5080*	5080*	3530*	3260			3330*	3230	6031
4,5 m					5710*	5050	4890*	3220			3190*	2590	6838
3,0 m					6740*	4710	4980	3090			3230*	2310	7248
1,5 m					7530*	4420	4830	2950			3440*	2220	7330
0 m			5580*	5580*	7450	4260	4730	2860			3710	2290	7094
- 1,5 m	6310*	6310*	9440*	8090	6950*	4240	4720	2850			4200	2570	6508
- 3,0 m	8760*	8760*	7190*	7190*	5360*	4340					4000*	3350	5454
- 4,5 m			2810*	2810*							2280*	2280*	3524













CAPACIDADES DE ELEVACIÓN – LONGITUD DEL BALANCÍN: 2,70 M, MONOBOOM 5,15 M, ESTABILIZADORES TRASEROS, SIN CAZO.

JSI75W MONO

Alcance	1,5 m		3 m		4,5 m		6 m		7,5 m		Capacidad a alcance máx.		mm
													
Altura del punto de carga	kg	kg	kg	kg	kg	kg	kg	kg	kg	kg	kg	kg	
7,5 m											2880*	2880*	5238
6,0 m							4040*	3350			2580*	2580*	6514
4,5 m					5290*	5160	4610*	3280			2500*	2380	7266
3,0 m			9710*	9010	6360*	4790	5030	3120	3370*	2210	2540*	2140	7653
1,5 m			5120*	5120*	7290*	4440	4850	2960	3460	2150	2690*	2050	7731
0 m			6660*	6660*	7420	4230	4720	2850	3080*	2110	3020*	2100	7508
- 1,5 m	6070*	6070*	10.140*	7900	7170*	4170	4670	2810			3630*	2320	6957
- 3,0 m	10.160*	10.160*	8130*	8060	5930*	4240					4020*	2890	5985
- 4,5 m			4570*	4570*							3120*	3120*	4307

CAPACIDADES DE ELEVACIÓN – LONGITUD DEL BALANCÍN: 3,05 M, MONOBOOM 5,15 M, ESTABILIZADORES TRASEROS, SIN CAZO.

JSI75W MONO

Alcance	1,5 m		3 m		4,5 m		6 m		7,5 m		Capacidad a alcance máx.		mm
													
Altura del punto de carga	kg	kg	kg	kg	kg	kg	kg	kg	kg	kg	kg	kg	
7,5 m											2400*	2400*	5690
6,0 m							3840*	3360			2170*	2170*	6881
4,5 m							4350*	3270	2500*	2250	2110*	2110*	7596
3,0 m			8930*	8930*	6020*	4840	4830*	3120	3510	2190	2150*	1980	7967
1,5 m			6790*	6790*	7070*	4470	4840	2950	3430	2120	2280*	1800	8041
0 m			6950*	6950*	7430	4230	4649	2820	3360	2060	2540*	1940	7828
- 1,5 m	5610*	5610*	9860*	7860	7290*	4140	4620	2760			3040*	2120	7301
- 3,0 m	9050*	9050*	8780*	7990	6260*	4170	4430*	2790			3920*	2590	6383
- 4,5 m	7560*	7560*	5630*	5630*	3860*	3860*					3340*	3340*	4849

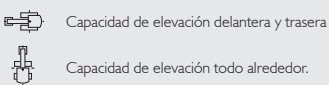











Notas:

1. Para obtener la capacidad de elevación incluyendo el cazo, sustraiga el peso total del cazo o el cazo y el enganche rápido de los valores anteriores.
2. Las capacidades de elevación están basadas en ISO 10567, es decir: 75 % de la carga basculante mínima u 87 % de la capacidad de elevación del sistema hidráulico, la que sea menor. Las capacidades de elevación marcadas con un asterisco (*) se basan en la capacidad del sistema hidráulico.
3. Para las capacidades de elevación se presupone que la máquina está en un terreno firme y nivelado.
4. Las capacidades de elevación pueden estar limitadas por las normas locales. Póngase en contacto con su distribuidor.



CAPACIDADES DE ELEVACIÓN – LONGITUD DEL BALANCÍN: 2,25 M, MONOBOOM 5,15 M, DÓZER DELANTERO, ESTABILIZADORES TRASEROS, SIN CAZO.

JSI75W MONO

Alcance	1,5 m		3 m		4,5 m		6 m		7,5 m		Capacidad a alcance máx.		
													mm
Altura del punto de carga	kg	kg	kg	kg	kg	kg	kg	kg	kg	kg	kg	kg	mm
7,5 m					4360*	4360*					3830*	3830*	4620
6,0 m					5080*	5080*	3530*	3530*			3330*	3330*	6031
4,5 m					5710*	5710*	4890*	4110			3190*	3090*	6838
3,0 m					6740*	6160	5250*	3970			3230*	2980	7248
1,5 m					7530*	5830	5580*	3830			3440*	2870	7330
0 m			5580*	5580*	7600*	5670	5600*	3740			3880*	2970	7094
- 1,5 m	6310*	6310*	9440*	9440*	6950*	5650	5060*	3730			4400*	3350	6508
- 3,0 m	8760*	8760*	7190*	7190*	5360*	5360*					4000*	4000*	5454
- 4,5 m			2810*	2810*							2280*	2280*	3524













CAPACIDADES DE ELEVACIÓN – LONGITUD DEL BALANCÍN: 2,70 M, MONOBOOM 5,15 M, DÓZER DELANTERO, ESTABILIZADORES TRASEROS, SIN CAZO.

JSI75W MONO

Alcance	1,5 m		3 m		4,5 m		6 m		7,5 m		Capacidad a alcance máx.		
													mm
Altura del punto de carga	kg	kg	kg	kg	kg	kg	kg	kg	kg	kg	kg	kg	mm
7,5 m											2880*	2880*	5238
6,0 m							4040*	4040*			2580*	2580*	6514
4,5 m					5290*	5290*	4610*	4170			2500*	2500*	7266
3,0 m			9710*	9710*	6360*	6240	5040*	4010	3370*	2850	2540*	2540*	7653
1,5 m			5120*	5120*	7290*	5860	5450*	3840	4100*	2780	2690*	2660	7731
0 m			6660*	6660*	7590*	5640	5600*	3720	3080*	2740	3020*	2730	7508
- 1,5 m	6070*	6070*	10.140*	10.140*	7170*	5570	5280*	3680			3630*	3030	6957
- 3,0 m	10.160*	10.160*	8130*	8130*	5930*	5640					4020*	3770	5985
- 4,5 m			4570*	4570*							3120*	3120*	4307

CAPACIDADES DE ELEVACIÓN – LONGITUD DEL BALANCÍN: 3,05 M, MONOBOOM 5,15 M, DÓZER DELANTERO, ESTABILIZADORES TRASEROS, SIN CAZO.

JSI75W MONO



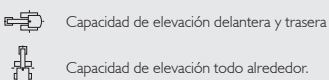







Alcance	1,5 m		3 m		4,5 m		6 m		7,5 m		Capacidad a alcance máx.		
													mm
Altura del punto de carga	kg	kg	kg	kg	kg	kg	kg	kg	kg	kg	kg	kg	mm
7,5 m											2400*	2400*	5690
6,0 m							3840*	3840*			2170*	2170*	6881
4,5 m							4350*	4170	2500*	2500*	2110*	2110*	7596
3,0 m			8930*	8930*	6020*	6020*	4830*	4010	3790*	2830	2150*	2150*	7967
1,5 m			6790*	6790*	7070*	5900	5300*	3830	4330*	2750	2280*	2280*	8041
0 m			6950*	6950*	7540*	5640	5540*	3700	4320*	2690	2540*	2530	7828
- 1,5 m	5610*	5610*	9860*	9860*	7290*	5540	5350*	3630			3040*	2780	7301
- 3,0 m	9050*	9050*	8780*	8780*	6260*	5580	4430*	3670			3920*	3380	6383
- 4,5 m	7560*	7560*	5630*	5630*	3860*	3860*					3340*	3340*	4849



- Notas:
1. Para obtener la capacidad de elevación incluyendo el cazo, sustraiga el peso total del cazo o el cazo y el enganche rápido de los valores anteriores.
 2. Las capacidades de elevación están basadas en ISO 10567, es decir: 75 % de la carga basculante mínima u 87 % de la capacidad de elevación del sistema hidráulico, la que sea menor. Las capacidades de elevación marcadas con un asterisco (*) se basan en la capacidad del sistema hidráulico.
 3. Para las capacidades de elevación se presupone que la máquina está en un terreno firme y nivelado.
 4. Las capacidades de elevación pueden estar limitadas por las normas locales. Póngase en contacto con su distribuidor.

CAPACIDADES DE ELEVACIÓN – LONGITUD DEL BALANCÍN: 2,25 M, MONOBOOM 5,15 M, ESTABILIZADORES DELANTEROS, ESTABILIZADORES TRASEROS, SIN CAZO.

JSI75W MONO

Alcance	1,5 m		3 m		4,5 m		6 m		7,5 m		Capacidad a alcance máx.		
													mm
Altura del punto de carga	kg	kg	kg	kg	kg	kg	kg	kg	kg	kg	kg	kg	mm
7,5 m					4360*	4360*					3830*	3830*	4620
6,0 m					5080*	5080*	3530*	3530*			3330*	3330*	6031
4,5 m					5710*	5710*	4890*	4670			3190*	3190*	6838
3,0 m					6740*	6740*	5250*	4520			3230*	3230*	7248
1,5 m					7530*	6750	5580*	4380			3440*	3270	7330
0 m			5580*	5580*	7600*	6580	5600*	4280			3880*	3390	7094
- 1,5 m	6310*	6310*	9440*	9440*	6950*	6550	5060*	4270			4400*	3830	6508
- 3,0 m	8760*	8760*	7190*	7190*	5360*	5360*					4000*	4000*	5454
- 4,5 m			2810*	2810*							2280*	2280*	3524

CAPACIDADES DE ELEVACIÓN – LONGITUD DEL BALANCÍN: 2,70 M, MONOBOOM 5,15 M, ESTABILIZADORES DELANTEROS, ESTABILIZADORES TRASEROS, SIN CAZO.



JSI75W MONO

Alcance	1,5 m		3 m		4,5 m		6 m		7,5 m		Capacidad a alcance máx.		
													mm
Altura del punto de carga	kg	kg	kg	kg	kg	kg	kg	kg	kg	kg	kg	kg	mm
7,5 m											2880*	2880*	5238
6,0 m							4040*	4040*			2580*	2580*	6514
4,5 m					5290*	5290*	4610*	4610*			2500*	2500*	7266
3,0 m			9710*	9710*	6360*	6360*	5040*	4570	3370*	3240	2540*	2540*	7653
1,5 m			5120*	5120*	7290*	6780	5450*	4390	4100*	3170	2690*	2690*	7731
0 m			6660*	6660*	7590*	6550	5600*	4270	3080*	3080	3020*	3020	7508
- 1,5 m	6070*	6070*	10.140*	10.140*	7170*	6480	5280*	4220			3630*	3460	6957
- 3,0 m	10.160*	10.160*	8130*	8130*	5930*	5930*					4020*	4020*	5985
- 4,5 m			4570*	4570*							3120*	3120*	4307

CAPACIDADES DE ELEVACIÓN – LONGITUD DEL BALANCÍN: 3,05 M, MONOBOOM 5,15 M, ESTABILIZADORES DELANTEROS, ESTABILIZADORES TRASEROS, SIN CAZO.

JSI75W MONO







Alcance	1,5 m		3 m		4,5 m		6 m		7,5 m		Capacidad a alcance máx.		
													mm
Altura del punto de carga	kg	kg	kg	kg	kg	kg	kg	kg	kg	kg	kg	kg	mm
7,5 m											2400*	2400*	5690
6,0 m							3840*	3840*			2170*	2170*	6881
4,5 m							4350*	4350*	2500*	2500*	2110*	2110*	7596
3,0 m			8930*	8930*	6020*	6020*	4830*	4560	3790*	3220	2150*	2150*	7967
1,5 m			6790*	6790*	7070*	6820	5300*	4380	4330*	3140	2280*	2280*	8041
0 m			6950*	6950*	7540*	6550	5540*	4240	4320*	3070	2540*	2540*	7828
- 1,5 m	5610*	5610*	9860*	9860*	7290*	6450	5350*	4180			3040*	3040*	7301
- 3,0 m	9050*	9050*	8780*	8780*	6260*	6260*	4430*	4210			3920*	3880	6383
- 4,5 m	7560*	7560*	5630*	5630*	3860*	3860*					3340*	3340*	4849

-  Capacidad de elevación delantera y trasera
-  Capacidad de elevación todo alrededor.













Notas:

1. Para obtener la capacidad de elevación incluyendo el cazo, sustraiga el peso total del cazo o el cazo y el enganche rápido de los valores anteriores.
2. Las capacidades de elevación están basadas en ISO 10567, es decir: 75 % de la carga basculante mínima u 87 % de la capacidad de elevación del sistema hidráulico, la que sea menor. Las capacidades de elevación marcadas con un asterisco (*) se basan en la capacidad del sistema hidráulico.
3. Para las capacidades de elevación se presupone que la máquina está en un terreno firme y nivelado.
4. Las capacidades de elevación pueden estar limitadas por las normas locales. Póngase en contacto con su distribuidor.

CAPACIDADES DE ELEVACIÓN – LONGITUD DEL BALANCIÓN: 2,25 M, T.A.B. 4,97 M, DÓZER TRASERO, SIN CAZO. JSI75W T.A.B.

Alcance	1,5 m		3 m		4,5 m		6 m		7,5 m		Capacidad a alcance máx.			
													mm	
Altura del punto de carga	kg	kg	kg	kg	kg	kg	kg	kg	kg	kg	kg	kg	mm	
7,5 m												4240*	4240*	4492
6,0 m					4690*	4560						3510*	2810	5935
4,5 m			6720*	6720*	5250*	4360	4630*	2750				3270*	2230	6753
3,0 m					6270*	4020	4990*	2630				3230*	1970	7168
1,5 m					7190*	3700	5390*	2480				3350*	1880	7251
0 m			5340*	5340*	7530*	3520	5540*	2390				3670*	1940	7013
- 1,5 m			10.110*	6460	7130*	3500	5140*	2380				4330*	2200	6419
- 3,0 m					5670*	3610						5100*	3240	4882

CAPACIDADES DE ELEVACIÓN – LONGITUD DEL BALANCIÓN: 2,70 M, T.A.B. 4,97 M, DÓZER TRASERO, SIN CAZO. JSI75W T.A.B.

Alcance	1,5 m		3 m		4,5 m		6 m		7,5 m		Capacidad a alcance máx.			
													mm	
Altura del punto de carga	kg	kg	kg	kg	kg	kg	kg	kg	kg	kg	kg	kg	mm	
7,5 m					4410*	4410*						3120*	3120*	5155
6,0 m					4240*	4240*	4170*	2880				2700*	2500	6448
4,5 m					4820*	4480	4330*	2820				2550*	2040	7207
3,0 m			8730*	7550	5870*	4110	4750*	2670	3200*	1860		2530*	1810	7597
1,5 m					6900*	3730	5220*	2500	3880*	1800		2630*	1730	7675
0 m			6410*	6280	7430*	3500	5490*	2380				2870*	1770	7451
- 1,5 m			10.500*	6290	7270*	3430	5330*	2330				3340*	1970	6895
- 3,0 m			8830*	6460	6230*	3500						4150*	2480	5913

CAPACIDADES DE ELEVACIÓN – LONGITUD DEL BALANCIÓN: 3,05 M, T.A.B. 4,97 M, DÓZER TRASERO, SIN CAZO. JSI75W T.A.B.



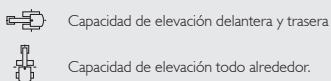

Alcance	1,5 m		3 m		4,5 m		6 m		7,5 m		Capacidad a alcance máx.			
													mm	
Altura del punto de carga	kg	kg	kg	kg	kg	kg	kg	kg	kg	kg	kg	kg	mm	
7,5 m												2580*	2580*	5629
6,0 m							3860*	2900				2270*	2250	6831
4,5 m					4440*	4440*	4050*	2820	2430*	1880		2150*	1860	7551
3,0 m			7950*	7800	5520*	4150	4520*	2670	3790*	1840		2140*	1660	7924
1,5 m			6890*	6730	6650*	3760	5040*	2490	4210*	1770		2230*	1590	7998
0 m			6710*	6310	7320*	3500	5400*	2350	4210*	1710		2420*	1620	7784
- 1,5 m	5120*	5120*	9850*	6250	7330*	3400	5370*	2290				2800*	1790	7254
- 3,0 m			9410*	6380	6530*	3430	4540*	2330				3590*	2200	6329



- Notas:
1. Para obtener la capacidad de elevación incluyendo el cazo, sustraiga el peso total del cazo o el cazo y el enganche rápido de los valores anteriores.
 2. Las capacidades de elevación están basadas en ISO 10567, es decir: 75 % de la carga basculante mínima u 87 % de la capacidad de elevación del sistema hidráulico, la que sea menor. Las capacidades de elevación marcadas con un asterisco (*) se basan en la capacidad del sistema hidráulico.
 3. Para las capacidades de elevación se presupone que la máquina está en un terreno firme y nivelado.
 4. Las capacidades de elevación pueden estar limitadas por las normas locales. Póngase en contacto con su distribuidor.













CAPACIDADES DE ELEVACIÓN – LONGITUD DEL BALANCIÓN: 2,25 M, T.A.B. 4,97 M, ESTABILIZADORES TRASEROS, SIN CAZO.

JSI75W T.A.B.

Alcance	1,5 m		3 m		4,5 m		6 m		7,5 m		Capacidad a alcance máx.		mm	
														
Altura del punto de carga	kg	kg	kg	kg	kg	kg	kg	kg	kg	kg	kg	kg		
7,5 m												4240*	4240*	4492
6,0 m					4690*	4690*						3510*	3330	5935
4,5 m			6720*	6720*	5250*	5170	4630*	3260				3270*	2660	6753
3,0 m					6270*	4810	4990*	3130				3230*	2360	7168
1,5 m					7190*	4480	4930	2980				3350*	2260	7251
0 m			5340*	5340*	7530*	4300	4820	2890				3670*	2340	7013
- 1,5 m			10.110*	8130	7130*	4270	4810	2880				4330*	2650	6419
- 3,0 m					5670*	4390						5100*	3920	4882

CAPACIDADES DE ELEVACIÓN – LONGITUD DEL BALANCIÓN: 2,70 M, T.A.B. 4,97 M, ESTABILIZADORES TRASEROS, SIN CAZO.

JSI75W T.A.B.

Alcance	1,5 m		3 m		4,5 m		6 m		7,5 m		Capacidad a alcance máx.		mm	
														
Altura del punto de carga	kg	kg	kg	kg	kg	kg	kg	kg	kg	kg	kg	kg		
7,5 m					4410*	4410*						3120*	3120*	5155
6,0 m					4240*	4240*	4170*	3400				2700*	2700*	6448
4,5 m					4820*	4820*	4330*	3330				2550*	2430	7207
3,0 m			8730*	8730*	5870*	4910	4750*	3180	3200*	2220		2530*	2170	7597
1,5 m					6900*	4520	4960	3000	3520	2160		2630*	2090	7675
0 m			6410*	6410*	7430*	4280	4810	2870				2870*	2140	7451
- 1,5 m			10.500*	7950	7270*	4200	4760	2830				3340*	2380	6895
- 3,0 m			8830*	8140	6230*	4280						4150*	2990	5913

CAPACIDADES DE ELEVACIÓN – LONGITUD DEL BALANCIÓN: 3,05 M, T.A.B. 4,97 M, DÓZER TRASERO, SIN CAZO.

JSI75W T.A.B.

Alcance	1,5 m		3 m		4,5 m		6 m		7,5 m		Capacidad a alcance máx.		mm	
														
Altura del punto de carga	kg	kg	kg	kg	kg	kg	kg	kg	kg	kg	kg	kg		
7,5 m												2580*	2580*	5629
6,0 m							3860*	3420				2270*	2270*	6831
4,5 m					4440*	4440*	4050*	3340	2430*	2250		2150*	2150*	7551
3,0 m			7950*	7950*	5520*	4960	4520*	3180	3580	2210		2140*	2000	7924
1,5 m			6890*	6890*	6650*	4550	4950	2990	3490	2130		2230*	1920	7998
0 m			6710*	6710*	7320*	4280	4790	2850	3430	2070		2420*	1970	7784
- 1,5 m	5120*	5120*	9850*	7920	7330*	4170	4710	2780				2800*	2170	7254
- 3,0 m			9410*	8050	6530*	4210	4540*	2830				3590*	2660	6329

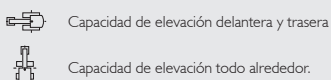

Notas:

1. Para obtener la capacidad de elevación incluyendo el cazo, sustraiga el peso total del cazo o el cazo y el enganche rápido de los valores anteriores.
2. Las capacidades de elevación están basadas en ISO 10567, es decir: 75 % de la carga basculante mínima u 87 % de la capacidad de elevación del sistema hidráulico, la que sea menor. Las capacidades de elevación marcadas con un asterisco (*) se basan en la capacidad del sistema hidráulico.
3. Para las capacidades de elevación se presupone que la máquina está en un terreno firme y nivelado.
4. Las capacidades de elevación pueden estar limitadas por las normas locales. Póngase en contacto con su distribuidor.













CAPACIDADES DE ELEVACIÓN – LONGITUD DEL BALANCIÓN: 2,25 M, T.A.B. 4,97 M, DÓZER DELANTERO, ESTABILIZADORES TRASEROS, SIN CAZO.

JSI75W T.A.B.

Alcance	1,5 m		3 m		4,5 m		6 m		7,5 m		Capacidad a alcance máx.		
													mm
Altura del punto de carga	kg	kg	kg	kg	kg	kg	kg	kg	kg	kg	kg	kg	mm
7,5 m												4240*	4492
6,0 m					4690*	4690*						3510*	5935
4,5 m			6720*	6720*	5250*	5250*	4630*	4180				3270*	6753
3,0 m					6270*	6270*	4990*	4040				3230*	7168
1,5 m					7190*	5940	5390*	3890				3350*	7251
0 m			5340*	5340*	7530*	5750	5540*	3790				3670*	7013
- 1,5 m			10.110*	10.110*	7130*	5710	5140*	3780				4330*	6419
- 3,0 m					5670*	5670*						5100*	4882





CAPACIDADES DE ELEVACIÓN – LONGITUD DEL BALANCIÓN: 2,70 M, T.A.B. 4,97 M, DÓZER DELANTERO, ESTABILIZADORES TRASEROS, SIN CAZO.



JSI75W T.A.B.

Alcance	1,5 m		3 m		4,5 m		6 m		7,5 m		Capacidad a alcance máx.		
													mm
Altura del punto de carga	kg	kg	kg	kg	kg	kg	kg	kg	kg	kg	kg	kg	mm
7,5 m					4410*	4410*						3120*	5155
6,0 m					4240*	4240*	4170*	4170*				2700*	6448
4,5 m					4820*	4820*	4330*	4260				2550*	7207
3,0 m			8730*	8730*	5870*	5870*	4750*	4090	3200*	2880		2530*	7597
1,5 m					6900*	5980	5220*	3910	3880*	2810		2630*	7675
0 m			6410*	6410*	7430*	5720	5490*	3770				2870*	7451
- 1,5 m			10.500*	10.500*	7270*	5640	5330*	3730				3340*	6895
- 3,0 m			8830*	8830*	6230*	5720						4150*	5913

CAPACIDADES DE ELEVACIÓN – LONGITUD DEL BALANCIÓN: 3,05 M, T.A.B. 4,97 M, DÓZER DELANTERO, ESTABILIZADORES TRASEROS, SIN CAZO.

JSI75W T.A.B.

Alcance	1,5 m		3 m		4,5 m		6 m		7,5 m		Capacidad a alcance máx.		
													mm
Altura del punto de carga	kg	kg	kg	kg	kg	kg	kg	kg	kg	kg	kg	kg	mm
7,5 m												2580*	5629
6,0 m							3860*	3860*				2270*	6831
4,5 m					4440*	4440*	4050*	4050*	2430*	2430*		2150*	7551
3,0 m			7950*	7950*	5520*	5520*	4520*	4090	3790*	2870		2140*	7924
1,5 m			6890*	6890*	6650*	6020	5040*	3900	4210*	2790		2230*	7998
0 m			6710*	6710*	7320*	5730	5400*	3750	4210*	2720		2420*	7784
- 1,5 m	5120*	5120*	9850*	9850*	7330*	5610	5370*	3680				2800*	7254
- 3,0 m			9410*	9410*	6530*	5650	4540*	3730				3590*	6329

-  Capacidad de elevación delantera y trasera
-  Capacidad de elevación todo alrededor.

Notas:

1. Para obtener la capacidad de elevación incluyendo el cazo, sustraiga el peso total del cazo o el cazo y el enganche rápido de los valores anteriores.
2. Las capacidades de elevación están basadas en ISO 10567, es decir: 75 % de la carga basculante mínima u 87 % de la capacidad de elevación del sistema hidráulico, la que sea menor. Las capacidades de elevación marcadas con un asterisco (*) se basan en la capacidad del sistema hidráulico.
3. Para las capacidades de elevación se presupone que la máquina está en un terreno firme y nivelado.
4. Las capacidades de elevación pueden estar limitadas por las normas locales. Póngase en contacto con su distribuidor.









CAPACIDADES DE ELEVACIÓN – LONGITUD DEL BALANCIÓN: 2,25 M, T.A.B. 4,97 M, ESTABILIZADORES DELANTEROS, ESTABILIZADORES TRASEROS, SIN CAZO.

JSI75W T.A.B.

Alcance	1,5 m		3 m		4,5 m		6 m		7,5 m		Capacidad a alcance máx.			
														
Altura del punto de carga	kg	kg	kg	kg	kg	kg	kg	kg	kg	kg	kg	kg	mm	
7,5 m												4240*	4240*	4492
6,0 m						4690*	4690*					3510*	3510*	5935
4,5 m			6720*	6720*	5250*	5250*	4630*	4630*				3270*	3270*	6753
3,0 m					6270*	6270*	4990*	4610				3230*	3230*	7168
1,5 m					7190*	6880	5390*	4450				3350*	3350*	7251
0 m			5340*	5340*	7530*	6680	5540*	4340				3670*	3490	7013
- 1,5 m			10.110*	10.110*	7130*	6640	5140*	4330				4330*	3970	6419
- 3,0 m					5670*	5670*						5100*	5100*	4882

CAPACIDADES DE ELEVACIÓN – LONGITUD DEL BALANCIÓN: 2,70 M, T.A.B. 4,97 M, ESTABILIZADORES DELANTEROS, ESTABILIZADORES TRASEROS, SIN CAZO.

JSI75W T.A.B.

Alcance	1,5 m		3 m		4,5 m		6 m		7,5 m		Capacidad a alcance máx.			
														
Altura del punto de carga	kg	kg	kg	kg	kg	kg	kg	kg	kg	kg	kg	kg	mm	
7,5 m						4410*	4410*					3120*	3120*	5155
6,0 m						4240*	4240*	4170*	4170*			2700*	2700*	6448
4,5 m						4820*	4820*	4330*	4330*			2550*	2550*	7207
3,0 m			8730*	8730*	5870*	5870*	4750*	4660	3200*	3200*		2530*	2530*	7597
1,5 m					6900*	6900*	5220*	4470	3880*	3210		2630*	2630*	7657
0 m			6410*	6410*	7430*	6660	5490*	4330				2870*	2870*	7451
- 1,5 m			10.500*	10.500*	7270*	6570	5330*	4290				3340*	3340*	6895
- 3,0 m			8830*	8830*	6230*	6230*						4150*	4150*	5913

CAPACIDADES DE ELEVACIÓN – LONGITUD DEL BALANCIÓN: 3,05 M, T.A.B. 4,97 M, ESTABILIZADORES DELANTEROS, ESTABILIZADORES TRASEROS, SIN CAZO.

JSI75W T.A.B.

Alcance	1,5 m		3 m		4,5 m		6 m		7,5 m		Capacidad a alcance máx.			
														
Altura del punto de carga	kg	kg	kg	kg	kg	kg	kg	kg	kg	kg	kg	kg	mm	
7,5 m												2580*	2580*	5629
6,0 m								3860*	3860*			2270*	2270*	6831
4,5 m						4440*	4440*	4050*	4050*	2430*	2430*	2150*	2150*	7551
3,0 m			7950*	7950*	5520*	5520*	4520*	4520*	3790*	3260		2140*	2140*	7924
1,5 m			6890*	6890*	6650*	6650*	5040*	4460	4210*	3180		2230*	2230*	7998
0 m			6710*	6710*	7320*	6660	5400*	4310	4210*	3126		2420*	2420*	7784
- 1,5 m	5120*	5120*	9850*	9850*	7330*	6540	5370*	4240				2800*	2800*	7254
- 3,0 m			9410*	9410*	6530*	6530*	4540*	4290				3590*	3590*	6329

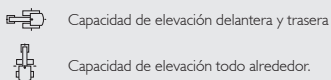

Notas:

1. Para obtener la capacidad de elevación incluyendo el cazo, sustraiga el peso total del cazo o el cazo y el enganche rápido de los valores anteriores.
2. Las capacidades de elevación están basadas en ISO 10567, es decir: 75 % de la carga basculante mínima u 87 % de la capacidad de elevación del sistema hidráulico, la que sea menor. Las capacidades de elevación marcadas con un asterisco (*) se basan en la capacidad del sistema hidráulico.
3. Para las capacidades de elevación se presupone que la máquina está en un terreno firme y nivelado.
4. Las capacidades de elevación pueden estar limitadas por las normas locales. Póngase en contacto con su distribuidor.



UN FABRICANTE, MÁS DE 300 MODELOS.

Su distribuidor JCB más cercano

Excavadora de ruedas JS175W

Potencia del motor: 129 kW (173 hp) Capacidad del cazo: 0,25 – 0,87 m³
 Peso operativo: 16.256 – 18.982 kg

JCB Sales Limited, Rocoeter, Staffordshire, United Kingdom ST14 5JP.

Tel: +44 (0)1889 590312 Correo electrónico: salesinfo@jcb.com

Descárguese la última información sobre esta gama de productos en: www.jcb.com

©2009 JCB Sales. Todos los derechos reservados. Ninguna parte de esta publicación puede reproducirse, almacenarse, guardarse en sistemas de recuperación ni transmitirse de ninguna manera electrónica, mecánica, de fotocopias o similar sin el permiso previo por escrito de JCB Sales. Todas las referencias a pesos operativos, tamaños o capacidades de funcionamiento, así como otras medidas de rendimiento se suministran a modo de guía solamente, y pueden variar según la especificación exacta de la máquina. Por lo tanto, estas referencias no deberán tenerse como fiables en relación con la idoneidad para una aplicación concreta. Consulte siempre con su distribuidor JCB en materia de asesoramiento y orientación. JCB se reserva el derecho a cambiar las especificaciones sin previo aviso. Las ilustraciones y especificaciones mostradas pueden incluir equipamientos opcionales. Todas las imágenes son correctas en el momento de impresión. El logotipo JCB es una marca registrada de J. C. Bamford Excavators Ltd.

29597 es-ES 11/21 Edición I

